

Single Phase Bridge (Power Modules), 25/35 A

MB
FEATURES

- Universal, 3 way terminals:
Push-on, wrap around or solder
- High thermal conductivity package, electrically insulated case
- Center hole fixing
- Excellent power/volume ratio
- UL E300359 approved
- Nickel plated terminals solderable using lead (Pb)-free solder; Solder Alloy Sn/Ag/Cu (SAC305); Solder temperature 260 to 275 °C
- RoHS compliant
- Designed and qualified for industrial level

RoHS
COMPLIANT

PRODUCT SUMMARY

$I_{T(AV)}$	25/35 A
-------------	---------

DESCRIPTION

A range of extremely compact, encapsulated single phase bridge rectifiers offering efficient and reliable operation. They are intended for use in general purpose and instrumentation applications.

MAJOR RATINGS AND CHARACTERISTICS

SYMBOL	CHARACTERISTICS	26MB-A	36MB-A	UNITS
I_o		25	35	A
	T_c	65	60	°C
I_{FSM}	50 Hz	400	475	A
	60 Hz	420	500	
I^2t	50 Hz	790	1130	A ² s
	60 Hz	725	1030	
V_{RRM}	Range	200 to 1200		V
T_J		- 55 to 150		°C

ELECTRICAL SPECIFICATIONS
VOLTAGE RATINGS

TYPE NUMBER	VOLTAGE CODE	V_{RRM} , MAXIMUM REPETITIVE PEAK REVERSE VOLTAGE V	V_{RSM} , MAXIMUM NON-REPETITIVE PEAK REVERSE VOLTAGE V	I_{RRM} MAXIMUM AT T_J MAXIMUM
26MB..A 36MB..A	20	200	275	2
	40	400	500	
	60	600	725	
	80	800	900	
	100	1000	1100	
	120	1200	1300	

FORWARD CONDUCTION							
PARAMETER	SYMBOL	TEST CONDITIONS		26MB-A	36MB-A	UNITS	
Maximum DC output current at case temperature	I _O	Resistive or inductive load		25	35	A	
		Capacitive load		20	28		
				65	60	°C	
Maximum peak, one-cycle non-repetitive forward current	I _{FSM}	t = 10 ms	No voltage reapplied	Initial T _J = T _J maximum	400	475	A
		t = 8.3 ms					
		t = 10 ms	100 % V _{RRM} reapplied		335	400	
		t = 8.3 ms					
Maximum I ² t for fusing	I ² t	t = 10 ms	No voltage reapplied	Initial T _J = T _J maximum	790	1130	A ² s
		t = 8.3 ms					
		t = 10 ms	100 % V _{RRM} reapplied		560	800	
		t = 8.3 ms					
Maximum I ² √t for fusing	I ² √t	I ² t for time t _x = I ₂ √t × √t _x ; 0.1 ≤ t _x ≤ 10 ms, V _{RRM} = 0 V		5.6	11.3	kA ² √s	
Low level value of threshold voltage	V _{F(TO)1}	(16.7 % × π × I _{F(AV)}) < I < π × I _{F(AV)} , T _J maximum		0.76	0.79	V	
High level value of threshold voltage	V _{F(TO)2}	(I > π × I _{F(AV)}), T _J maximum		0.92	0.96		
Low level forward slope resistance	r _{t1}	(16.7 % × π × I _{F(AV)}) < I < π × I _{F(AV)} , T _J maximum		6.8	5.8	mΩ	
High level forward slope resistance	r _{t2}	(I > π × I _{F(AV)}), T _J maximum		5.0	4.5		
Maximum forward voltage drop	V _{FM}	T _J = 25 °C, I _{FM} = 40 A _{pk} (26MB)		t _p = 400 μs	1.11	1.14	V
		T _J = 25 °C, I _{FM} = 55 A _{pk} (36MB)					
Maximum DC reverse current	I _{RRM}	T _J = 25 °C, per diode at V _{RRM}		10		μA	
RMS isolation voltage base plate	V _{INS}	f = 50 Hz, t = 1 s		2700		V	

THERMAL AND MECHANICAL SPECIFICATIONS						
PARAMETER	SYMBOL	TEST CONDITIONS		26MB-A	36MB-A	UNITS
Junction and storage temperature range	T _J , T _{Stg}			- 55 to 150		°C
Maximum thermal resistance junction to case per bridge	R _{thJC}			1.7	1.2	K/W
Maximum thermal resistance, case to heatsink	R _{thCS}	Mounting surface, smooth, flat and greased		0.2		
Approximate weight				20		g
Mounting torque ± 10 %		Bridge to heatsink		2.0		Nm



Single Phase Bridge Vishay High Power Products
(Power Modules), 25/35 A

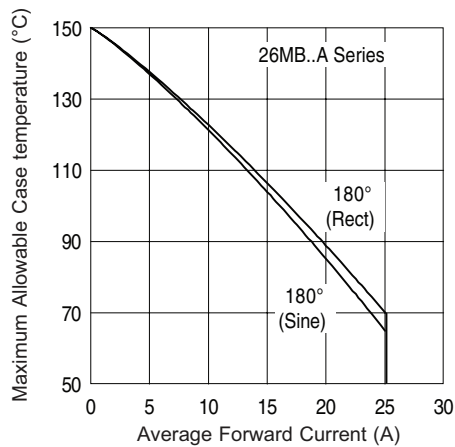

Fig. 1 - Current Ratings Characteristics

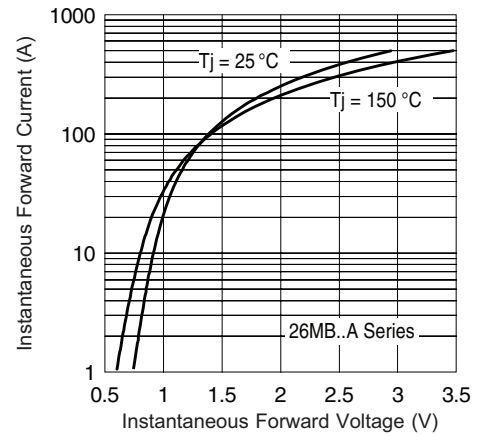

Fig. 2 - Forward Voltage Drop Characteristics
Maximum Allowable Ambient Temperature

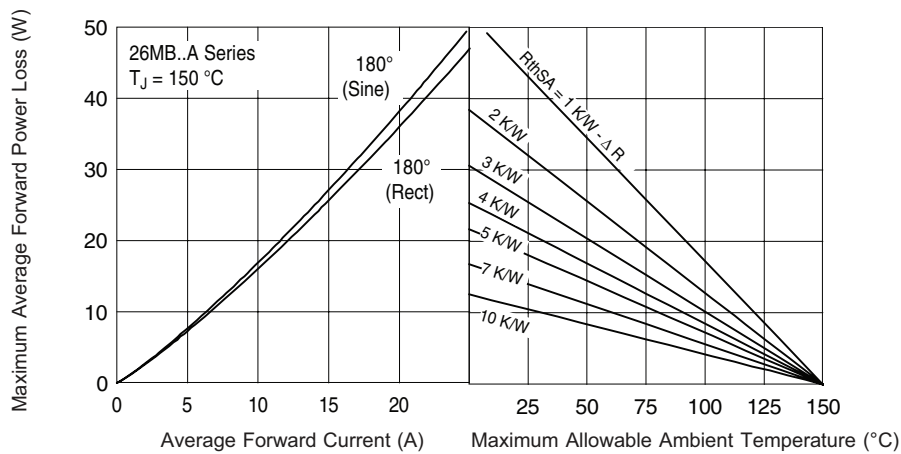

Fig. 3 - Total Power Loss Characteristics

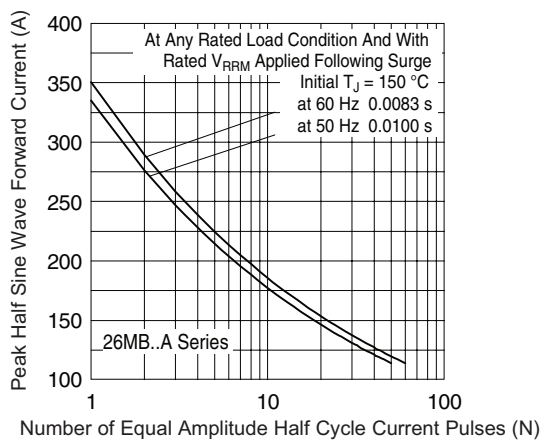

Fig. 4 - Maximum Non-Repetitive Surge Current

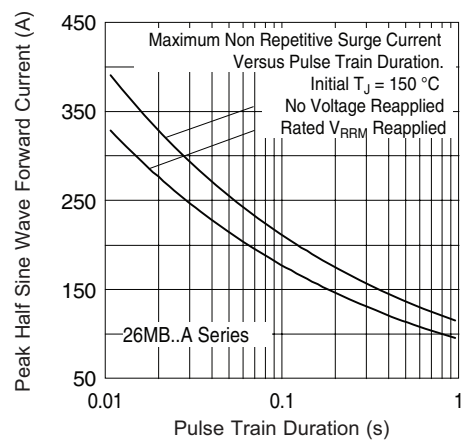

Fig. 5 - Maximum Non-Repetitive Surge Current

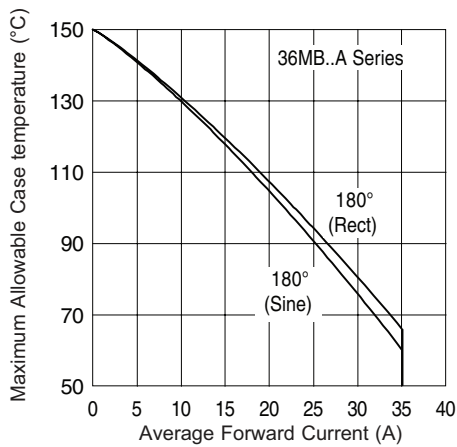

Fig. 6 - Current Ratings Characteristics

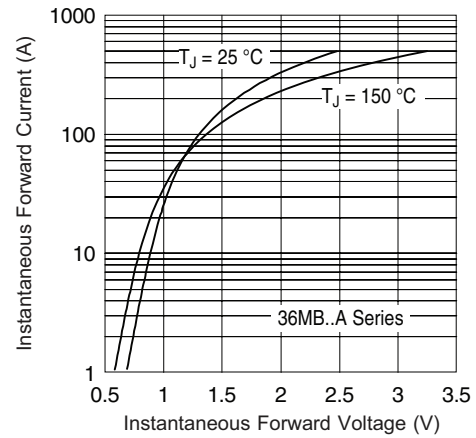

Fig. 7 - Forward Voltage Drop Characteristics

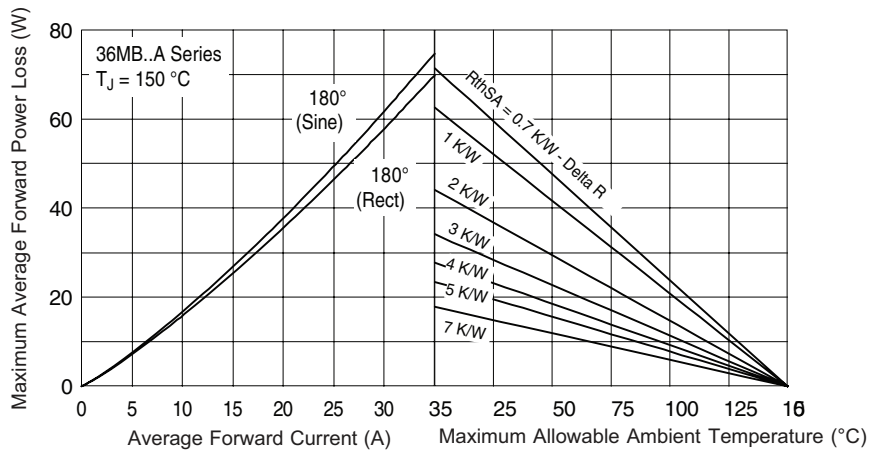

Fig. 8 - Total Power Loss Characteristics

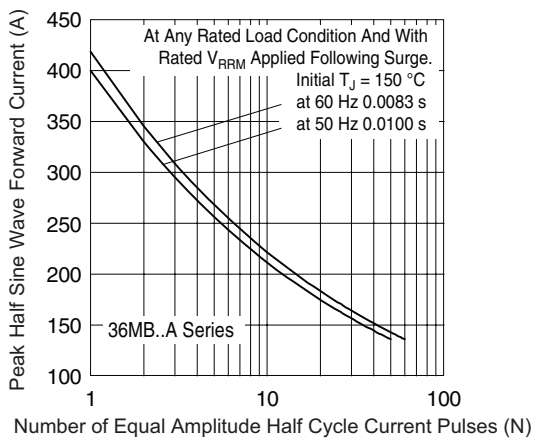

Fig. 9 - Maximum Non-Repetitive Surge Current

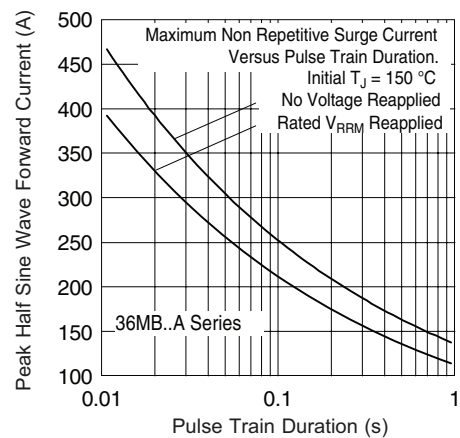
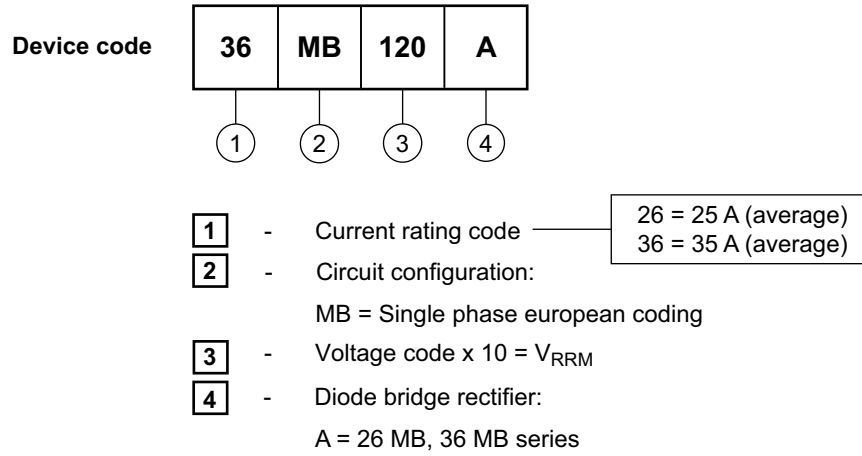
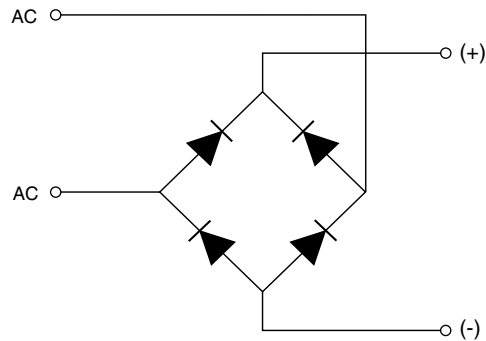

Fig. 10 - Maximum Non-Repetitive Surge Current

ORDERING INFORMATION TABLE



CIRCUIT CONFIGURATION



LINKS TO RELATED DOCUMENTS	
Dimensions	http://www.vishay.com/doc?95326



Disclaimer

All product specifications and data are subject to change without notice.

Vishay Intertechnology, Inc., its affiliates, agents, and employees, and all persons acting on its or their behalf (collectively, "Vishay"), disclaim any and all liability for any errors, inaccuracies or incompleteness contained herein or in any other disclosure relating to any product.

Vishay disclaims any and all liability arising out of the use or application of any product described herein or of any information provided herein to the maximum extent permitted by law. The product specifications do not expand or otherwise modify Vishay's terms and conditions of purchase, including but not limited to the warranty expressed therein, which apply to these products.

No license, express or implied, by estoppel or otherwise, to any intellectual property rights is granted by this document or by any conduct of Vishay.

The products shown herein are not designed for use in medical, life-saving, or life-sustaining applications unless otherwise expressly indicated. Customers using or selling Vishay products not expressly indicated for use in such applications do so entirely at their own risk and agree to fully indemnify Vishay for any damages arising or resulting from such use or sale. Please contact authorized Vishay personnel to obtain written terms and conditions regarding products designed for such applications.

Product names and markings noted herein may be trademarks of their respective owners.